

Instruction for thread sensor I5961 and I5962

Denna instruktion finns på svenska, TH-0198.
Diese Anleitung ist auf Deutsch erhältlich, TH-0042.
Cette instruction est disponible en français TH-0190.
Esta instrucción está disponible en español, TH-0169.
This instruction is available in Chinese, TH-0277.

www.eltex.se

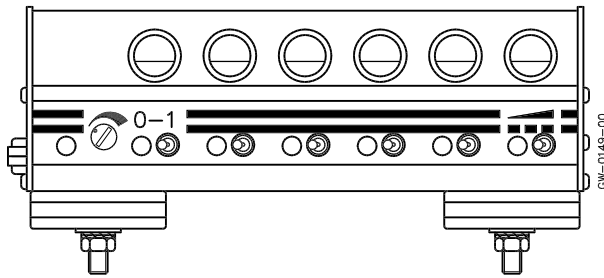

Fitting

Position the thread sensor after the thread brake. The thread motion is detected most effectively when the thread deviates about 10–15° from the horizontal, when it passes over the ceramic bar. Threads should not touch the aluminium housing.

Connection

The thread sensor is designed to be used with a PLC control system, either plus or minus connected to ground. The thread sensor housing must be connected to machine ground.

If the system has minus connected to ground, fit a link from connector pin 1 to pin 2.

If the system has plus connected to ground fit a link from pin 1 to pin 6.

The thread sensor has a run mode opto coupler input and a stop opto coupler output.

The PLC should be programmed to turn on the run mode opto coupler input, when the machine is in operation and threads are moving correctly.

- The run mode signal must be switched off as the machine is about to stop, otherwise the thread sensor will indicate a false stop.
- The thread sensor turns on the stop output opto coupler, if any thread moves incorrectly during run mode.
- As soon as the run mode is switched off after a thread stop, the stop output is deactivated; however, the stop indication will remain until next start of run mode, i.e. machine start again.

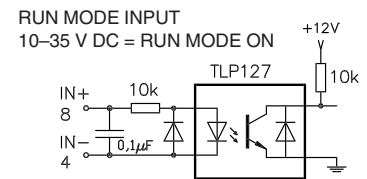
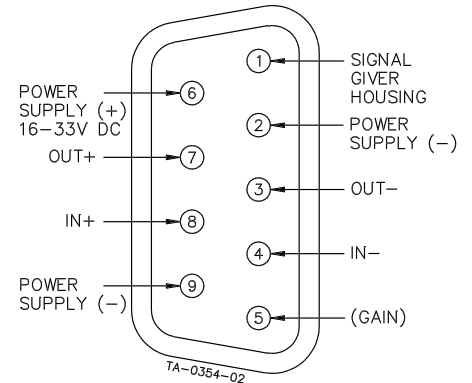

STOP OUTPUT
SPEC: 35 V/100 mA
TURNED ON AT STOP

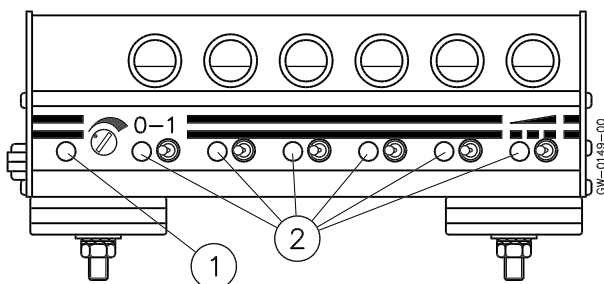
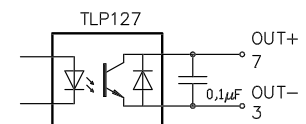

Indication

- ① The green LED indicates when the thread sensor is in run mode, sensing the movement of the threads.
- ② The 6 red LED's indicate in which position the thread sensor detected a fault.

The LED will light continuously when the thread is broken.

The LED will flash when the thread was moving continuously and not moving intermittent, as it should.

How to open and close the lid

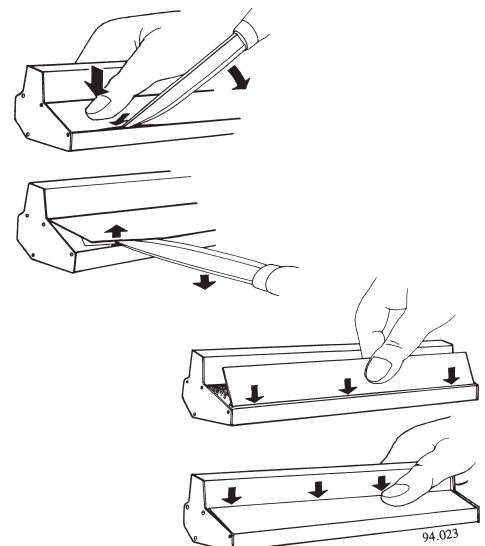

Switches

- ③ Each thread position has a switch, setting the corresponding eyelet ON or OFF (OFF = 0, ON = 1).

Adjustments

- ④ The sensitivity can be changed with the GAIN potentiometer. Maximum setting (clockwise) for thin threads or thread with low tension or small thread movement.
- ⑤ The delay time of the detector circuit can be adjusted by moving a connection shunt on a pin strip inside the thread sensor. The delay time must normally be longer than the time for two stitches.

If the delay is set too short, the thread sensor will stop for no apparent reason, indicating thread broken. If the delay is set too long, the stop signal at a broken thread will be delayed many stitches before operating. The thread sensor is delivered with a default setting in position 5, which is normally OK for speeds above 1200 rpm.

Shunt position	Delay (ms)
1	Not used
2	40
3	60
4	80
5	100 (factory setting)
6	120
7	140
8	160
9	180

- ⑥ ON: the thread sensor will stop if the thread moves continuously instead of stitchwise.
OFF: the thread sensor will not stop if the thread moves continuously.
- ⑦ The 6th eyelet (with symbol: ) can be made more sensitive than the other eyelets to detect a slower moving or a thinner thread. The sensitivity is changed for this eyelet by a potentiometer located inside the thread sensor. When this potentiometer is in counter-clockwise position, the sensitivity is equal to the other eyelets. When this potentiometer is in the clockwise stop position, the sensitivity is maximised for this eyelet. This setting only effects this eyelet.

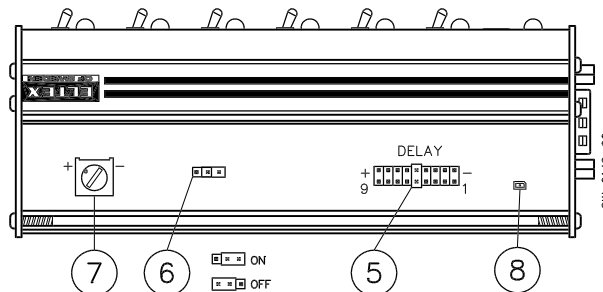
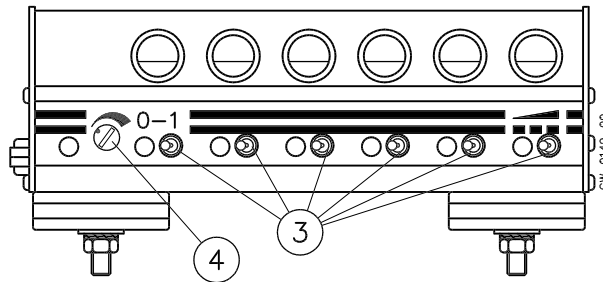

Trouble shooting

- Thread sensor stops for no reason, indicated by continuous light at any red LED (indicating broken thread):
– Increase the sensitivity setting clockwise.
- Thread sensor stops for no reason, indicated by flashing light at any red LED (indicating continuously moving thread):
– Decrease the sensitivity setting counter-clockwise.
- The sensitivity is difficult to set, increasing causes stops with flash indication and decreasing causes stops with continuous indication:
– Increase the delay time of the detector circuit. Try to set the sensitivity again.
- Thread sensor does not stop and no indication:
– Check that green LED is ON when run mode is activated. If not – check connection cables.
- Machine does not stop, but the thread sensor indicates stop:
– Check small LED (8) inside the thread sensor, this is ON when stop output is activated. Should be ON from stop detected until run mode is deactivated. If LED is ON and machine continues running, check connection cables.



Box 24 • SE-283 21 OSBY • Sweden • Tel. +46 479 53 63 00 • Fax +46 479 53 63 99
E-mail: info@eltex.se • Web: www.eltex.se

ELTEX U.S. INC.
13031 E. Wade Hampton Blvd
Greer, SC 29651
USA
Tel: 864-879-2131
In U.S. toll free: 1-800-421-1156
Fax: 864-879-3734
Email: sales@eltexus.com

ELTEX MFG LTD
Railway Road
Templemore, Co. Tipperary
Ireland
Tel: 504-314 33
Fax: 504-310 02
Email: info@eltex.ie

POLSA-ELTEX S.L.
Zamora, 103 - entlo 3
ES-08018 Barcelona
Spain
Tel: 093-309 00 17
Fax: 093-309 59 45
Email: polsa@infonegocio.com